

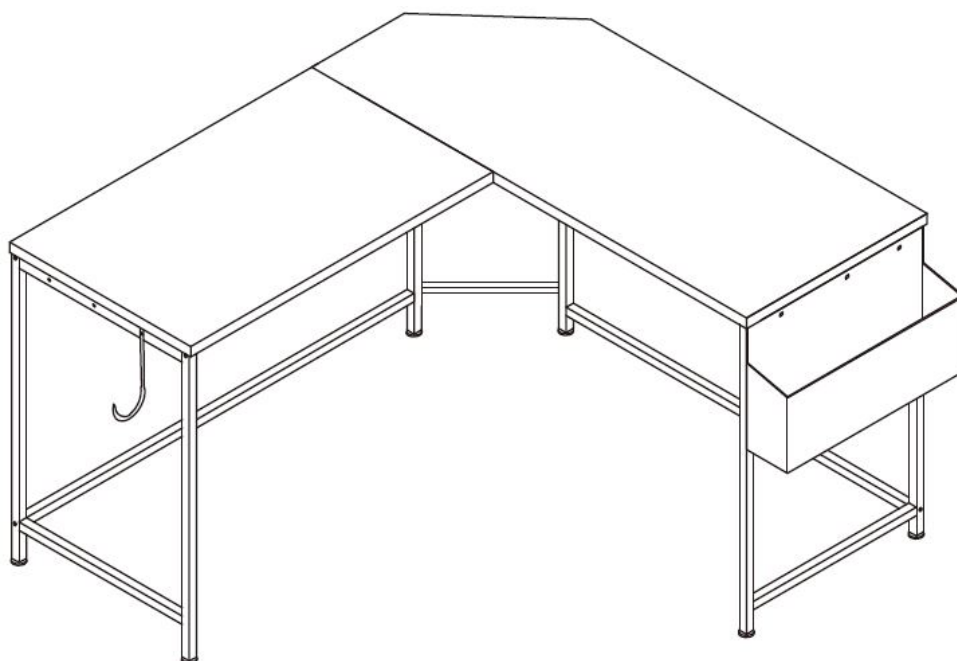

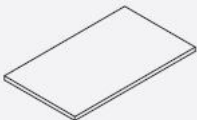

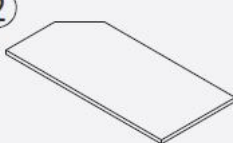

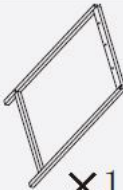





WORKSPACE L

hjh.[®]
OFFICE

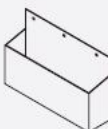
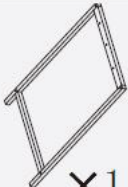

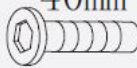
- | | | | |
|---|---|--|--|
| <p>①</p>  <p>×1</p> | <p>②</p>  <p>×1</p> | <p>③</p>  <p>×1</p> | <p>④</p>  <p>×1</p> |
| <p>⑤</p>  <p>×1</p> | <p>⑥</p>  <p>×1</p> | <p>⑦</p>  <p>×1</p> | <p>⑧</p>  <p>×2</p> |
| <p>⑨</p>  <p>×1</p> | <p>⑩</p>  <p>×1</p> | <p>⑪</p>  <p>×1</p> | <p>⑫</p>  <p>×1</p> |
| <p>⑬</p>  <p>×1</p> | <p>A</p> <p>12mm</p>  <p>×4</p> | <p>B</p> <p>35mm</p>  <p>×4</p> | <p>C</p> <p>40mm</p>  <p>×20</p> |
| <p>D</p>  <p>×6</p> | <p>E</p>  <p>×1</p> | | |

